

1A Low Dropout Positive Regulator

DESCRIPTION

The ST1117 is a positive low dropout voltage regulators with 1A output current capability.

In order to obtain lower dropout voltage and fast transient response, which is critical for low voltage application. The ST1117 has been optimized. The device is available in an adjustable version and fixed output voltage of 1.8V, 2.5V, 3.3V and 5V. Dropout voltage is guaranteed at a maximum of 1.3V at 1A.

Current limit is trimmed to ensure specified output current and controlled short circuit current. On-chip thermal limiting provides protection against any combination of overload that would create excessive junction temperatures.

The ST1117 is available in the SOT-223 and surface mount packages.

FEATURE

- ◆ Low Dropout Performance
- ◆ Adjustable or Fixed Output
- ◆ Over-temperature and Over-current Protection
- ◆ Current Limiting and Thermal Protection
- ◆ Output Current of 1A
- ◆ Rugged 2KV ESD withstand capability
- ◆ Full RoHS compliance

APPLICATIONS

- ◆ Battery Chargers.
- ◆ Post Regulator for Switching Power Supply
- ◆ Low Voltage Logic Suppliers
- ◆ High Efficiency Linear Regulators
- ◆ Motherboard Clock Supplies

ST1117XXA-TRG ROHS Compliant This is Halogen Free



PIN CONFIGURATION



SOT-223
Top View

PART NUMBER INFORMATION

$\frac{\text{ST}}{\text{a}} \frac{1117}{\text{b}} \frac{\text{XX}}{\text{c}} \frac{\text{A}}{\text{d}} - \frac{\text{TR}}{\text{e}} \frac{\text{G}}{\text{f}}$	<p>a : Company name. b : Product Serial number. c : Voltage Code. XX 18 : 1.8V, 25 : 2.5V, 33 : 3.3V ADJ : ADJ d : Package Code e : Handling Code f : Lead Plating Code G : Lead-free product</p>
--	--

ORDERING INFORMATION

Part Number	Package Code	Package	VOUT Voltage	Shipping
ST1117-XXA-TRG	A	SOT-223	ADJ 1.8 2.5 3.3	2500/Tape&Reel

- ※“XX”stands for output voltages.
- ※ Year Code : 0 ~ 9, 2010 : 0
- ※ Week Code : A(1~2) ~ Z(53~54)
- ※ SOT-223 : Only available in tape and reel packaging.

ABSOLUTE MAXIMUM RATINGS (T_A = 25°C Unless otherwise noted)

Symbol	Parameter	Maximum	Unit
P _D	Power Dissipation	Internally Limited	W
V _{IN}	Input Voltage	12	V
T _J	Operating Junction Temperature Range	0~+125	°C
T _{STG}	Storage Temperature Range	-65~+150	°C
T _{LEAD}	Lead Soldering Temperature (Soldering, 10 sec)	260	°C

Note: Exceeding these ratings could cause damage to the device. All voltages are with respect to Ground. Current are positive into, negative out of the specified terminal.

POWER DISSIPATION

Package	θ _{JA} (°C/W)	D _f (mW/°C) T _A ≥ 25°C	T _A ≤ 25°C Power rating (mW)	T _A = 70°C Power rating (mW)	T _A = 80°C Power rating (mW)
A	136	7.35	919	588	478

Note : θ_{JA} : Thermal Resistance-Junction to Ambient, D_F : Derating factor, P_C : Power consumption

Junction Temperature Calculation:

$$T_J = T_A + (P_D \times \theta_{JA}), P_O = D_F \times (T_J - T_A)$$

The θ_{JA} numbers are guidelines for the thermal performance of the device/PC-board system.

All of the above assume no ambient airflow.

θ_{JT} : Thermal Resistance-Junction to Tab, T_C : case(Tab) temperature, T_J = T_C + (P_D × θ_{JT})

For A package, θ_{JT} = 15.0 °C/W

ELECTRICAL CHARACTERISTICS ($T_A = 25^\circ\text{C}$ Unless otherwise noted)

$T = 25^\circ\text{C}$, $V = 3.6\text{V}$ unless otherwise noted.

Symbol	Parameter	Test Conditions	Min	Typ	Max	Unit
V_{OUT}	Output Voltage (1)	$I_{OUT} = 10\text{mA}$, $T_A = 25^\circ\text{C}$ ST1117-18, $3.3\text{V} \leq V_{IN} \leq 8.0\text{V}$ ST1117-25, $4.0\text{V} \leq V_{IN} \leq 8.0\text{V}$ ST1117-33, $4.8\text{V} \leq V_{IN} \leq 8.0\text{V}$	1.764 2.450 3.234	1.80 2.50 3.30	1.863 2.550 3.366	V
V_{REF}	Reference Voltage (1) (Adj. Version)	$V_{IN} = V_{OUT} + 1.5\text{V}$, $I_{OUT} = 10\text{mA}$ $V_{IN} = V_{OUT} + 1.5\text{V}$ to 8V $I_{OUT} = 10\text{mA}$ to 1A	1.238 1.225	1.250 1.250	1.262 1.275	V
V_{SR}	Line Regulation (1)	$(V_{OUT} + 1.5\text{V}) \leq V_{IN} \leq 8.0\text{V}$ $I_{OUT} = 10\text{mA}$ to 1A	-	0.1	0.5	%
V_{LR}	Load Regulation (1)	$10\text{mA} \leq I_{OUT} \leq 1\text{A}$ $V_{IN} - V_{OUT} = 1.5\text{V}$	-	-	1	%
V_D	Dropout Voltage	$I_{OUT} = 1\text{A}$	-	1.3	1.4	V
I_{CL}	Current Limit	$V_{IN} - V_{OUT} = 1.5\text{V}$	1.1	-	-	A
I_Q	Quiescent Current	$V_{IN} \leq 7\text{V}$	-	3	5	mA
I_{ADJ}	Adjust Pin Current	$I_{OUT} = 10\text{mA}$, $V_{IN} - V_{OUT} = 2\text{V}$	-	50	120	μA
T_C	Temperature Coefficient		-	0.5	-	$\% / ^\circ\text{C}$
I_{OUT}	Minimum Load Current	$1.5\text{V} \leq (V_{IN} - V_{OUT}) \leq 5.75\text{V}$	-	5	10	mA
RA	Ripple Rejection Ratio (3)	$f = 120\text{Hz}$, $1V_{RMS}$, $I_{OUT} = 400\text{mA}$, $V_{IN} - V_{OUT} = 3\text{V}$	-	60	70	dB

NOTES: (1) Low duty cycle pulse testing with which T_J remain unchanged.

(2) ST1117-XX.

(3) These parameters, although guaranteed, are not tested in production.

RECOMMEND OPERATING CONDITIONS

Symbol	Parameter	Operating Conditions			Unit
		Min	Typ	Max	
V_{IN}	Input Voltage	2.75	-	12	V
I_{OUT}	Load Current (With adequate heat sinking)	5	-	-	mA
C_{IN}	Input Capacitor (V_{IN} to GND)	1.0	-	-	μF
C_{OUT}	Output Capacitor with ESR of 10Ω Max (V_{OUT} to GND)	4.7			μF
T_J	Junction Temperature	-	-	150	$^\circ\text{C}$

APPLICATION NOTE

Maximum Power Dissipation Calculation:

$$P_D (max) = [(V_{IN} (max) - V_o (nom))] \times I_o (nom) + V_{IN} (max) \times I_Q$$

Where: $V_{OUT} (nom)$: The nominal output voltage
 $I_{OUT} (nom)$: The nominal output current, and
 I_Q : The quiescent current the regulator consumes at $I_o (max)$
 $V_{IN} (max)$: The maximum input voltage. Then $\theta_{JA} = (150^\circ\text{C} - T_A) / P_D$

TYPICAL APPLICATION

Adjustable Voltage Regulator

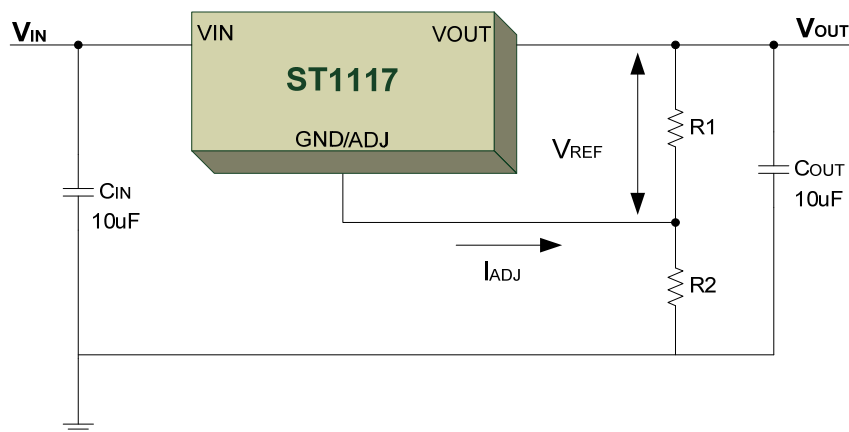

$$V_{OUT} = 1.25V \times \left(1 + \frac{R2}{R1}\right)$$

Fixed Voltage Regulator

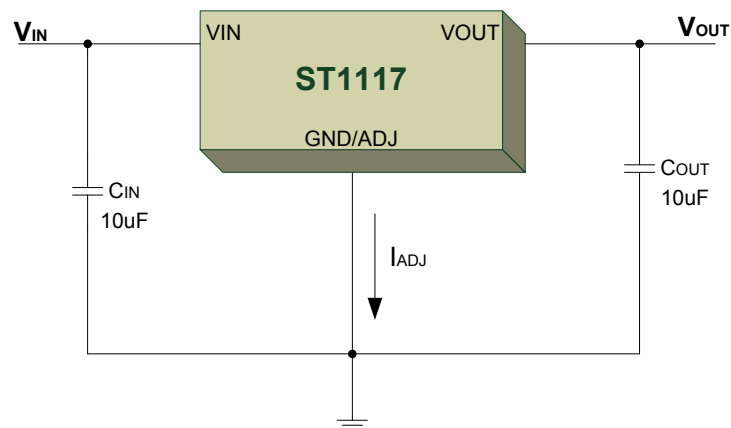

TYPICAL CHARACTERISTICS(25°C Unless Note)

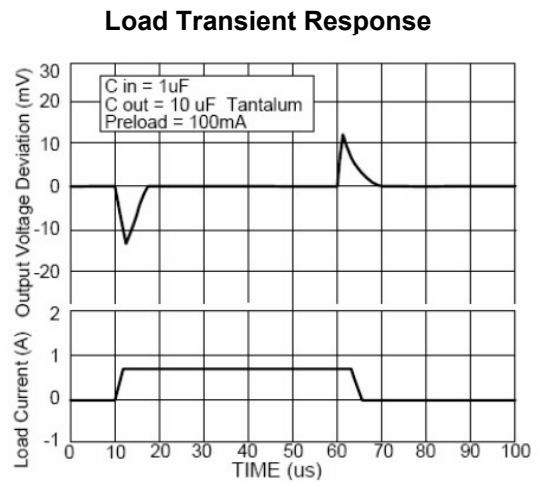
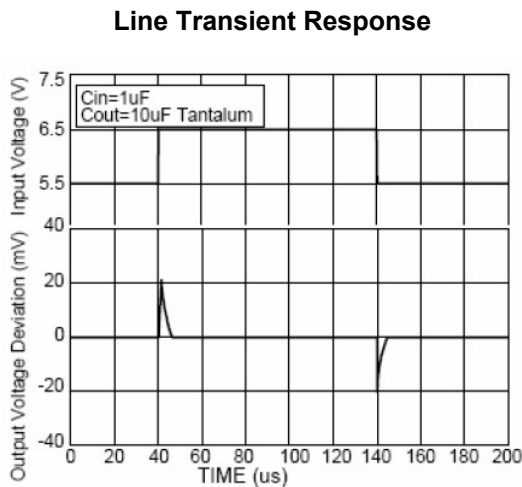
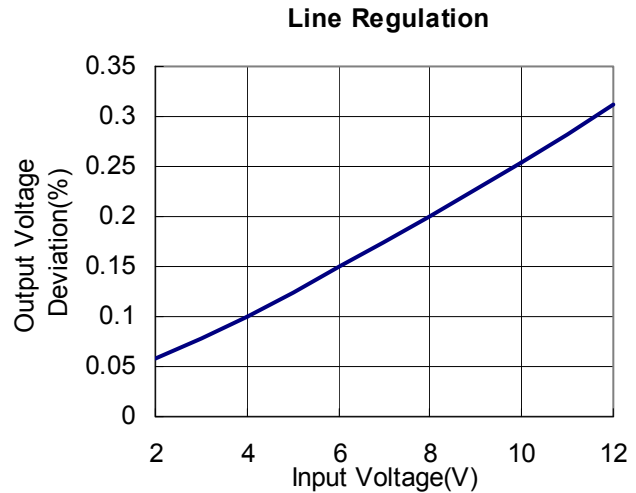
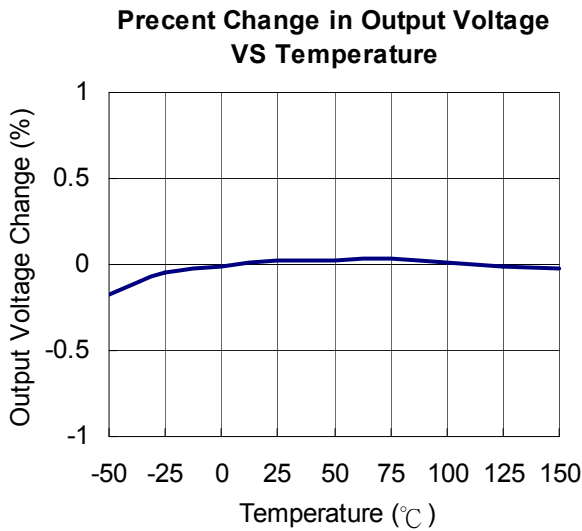
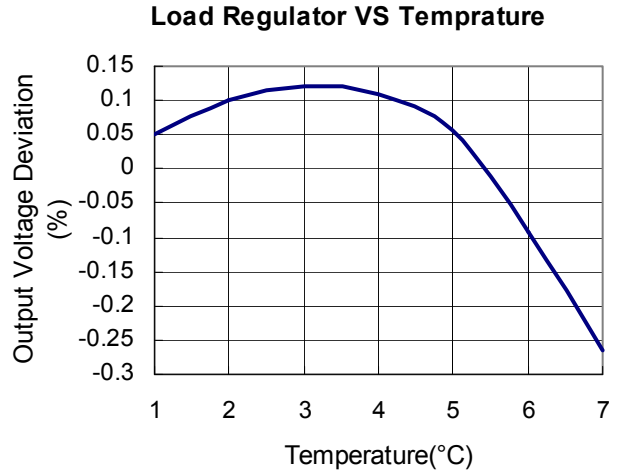
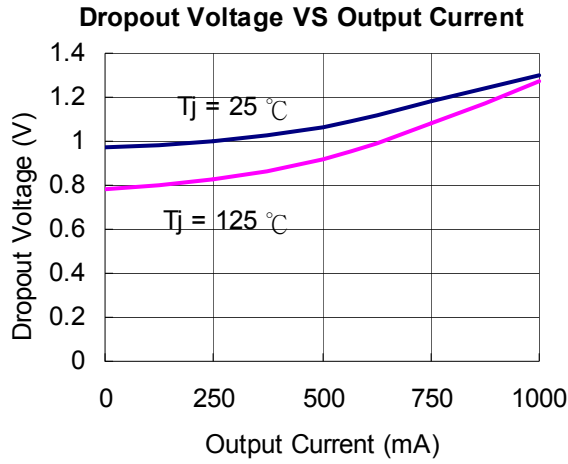

■ SOT-223 PACKAGE DIMENSIONS

Symbol	Dimensions In Millimeters		Dimensions In Inches	
	Min.	Max.	Min.	Max.
A	1.500	1.800	0.059	0.071
A1	0.030	0.090	0.001	0.004
A2	1.450	1.750	0.057	0.069
A3	0.800	1.000	0.031	0.039
b	0.690	0.780	0.027	0.031
b1	0.680	0.740	0.027	0.029
c	0.300	0.350	0.012	0.014
c1	0.290	0.310	0.011	0.012
D	0.630	6.700	0.025	0.264
D1	3.000 REF		0.118 REF	
E	6.800	7.200	0.268	0.283
E1	3.400	3.600	0.134	0.142
e	2.300 BSC		0.091 BSC	
L	0.900	-	0.035	-
L1	1.750 BSC		0.069 BSC	
θ	0°	7°	0°	7°
θ 1	37.500 REF		1.476 BSC	

